

ACO ShowerDrain

Plus 4x4 ShowerPoint

Grout Plate

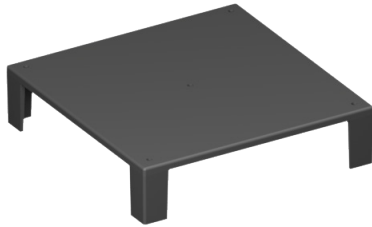

Strainer



Drain Body



Drain Flange



Tile-In



Satin Brass



Polished Chrome



Brushed Stainless



Matte Black



ACO ShowerDrain Plus

The ACO ShowerDrain Plus product range provides an economical way to mimic the high-end trend of designer shower drains. A stainless steel grate option of similar quality coupled with a cost-effective plastic body provides an affordable solution. All products are sealed in a package for care of installation.





ACO 4x4 ShowerPoint

Well known for its high-quality shower drainage products the world over, ACO Plus point drains are designed with quality and care to help create beautiful and timeless projects. ACO Plus point drains offer a stylish, artistic solution to bathroom floor design. Choose from grates manufactured with grade 304 stainless steel in a choice of four finishes or an ABS tile infill grate designed to allow architects and designers to incorporate the bathroom tile into the drainage motif.

ACO ShowerDrain

Plus 4x4 ShowerPoint

Product Table

Product	Design	Part #	Length/Width in (mm)	Slot Size in (mm)	Grate Intake sq. in (sq. cm)	Depth in (mm)	Weight lbs (kg)
	Brushed Stainless	143125	3.54 (90)	0.31 (8)	3.20 (20.5)	0.85 (22)	1.50 (0.7)
	Polished Chrome	143126					
	Matte Black	143127					
	Satin Brass	143128					
	Tile-In	143129					

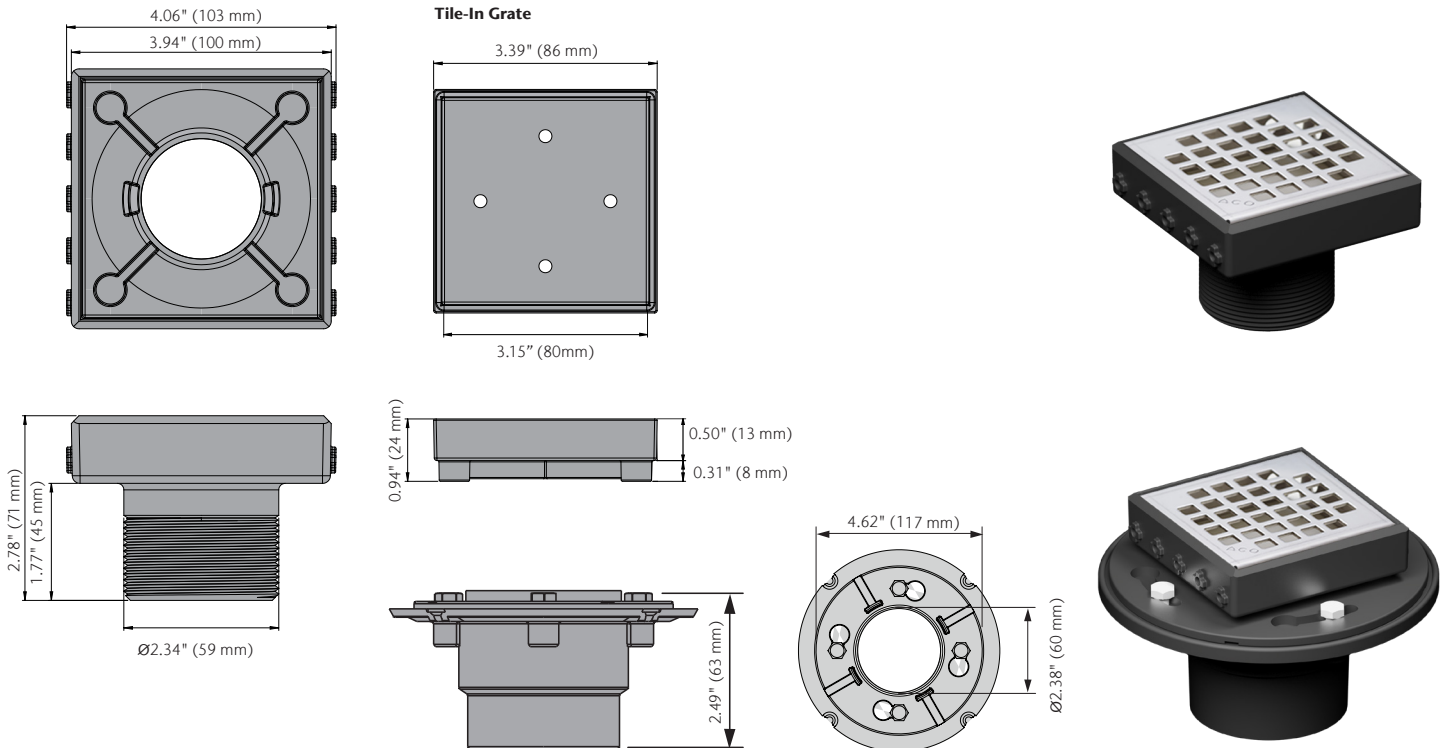

ACO, Inc.

West Sales Office
825 W. Beechcraft St.
Casa Grande, AZ 85122
Tel: 520-421-9988
Fax: 520-421-9899

North East Sales Office
9470 Pinecone Dr.
Mentor, OH 44060
Tel: 440-639-7230
Fax: 440-639-7235

South East Sales Office
4211 Pleasant Rd.
Fort Mill, SC 29708
Tel: 440-639-7230
Fax: 803-802-1063

info@acousa.com
www.acoshowerdrain.us

© February 2022 ACO, Inc. All reasonable care has been taken in compiling the information in this document. All recommendations and suggestions on the use of ACO products are made without guarantee since the conditions of use are beyond the control of the company. It is the customer's responsibility to ensure that each product is fit for its intended purpose and that the actual conditions of use are suitable. ACO, Inc. reserves the right to change products and specifications without notice. Print #SD400