

Hygienic Floor Drain, 8" Adjustable Top

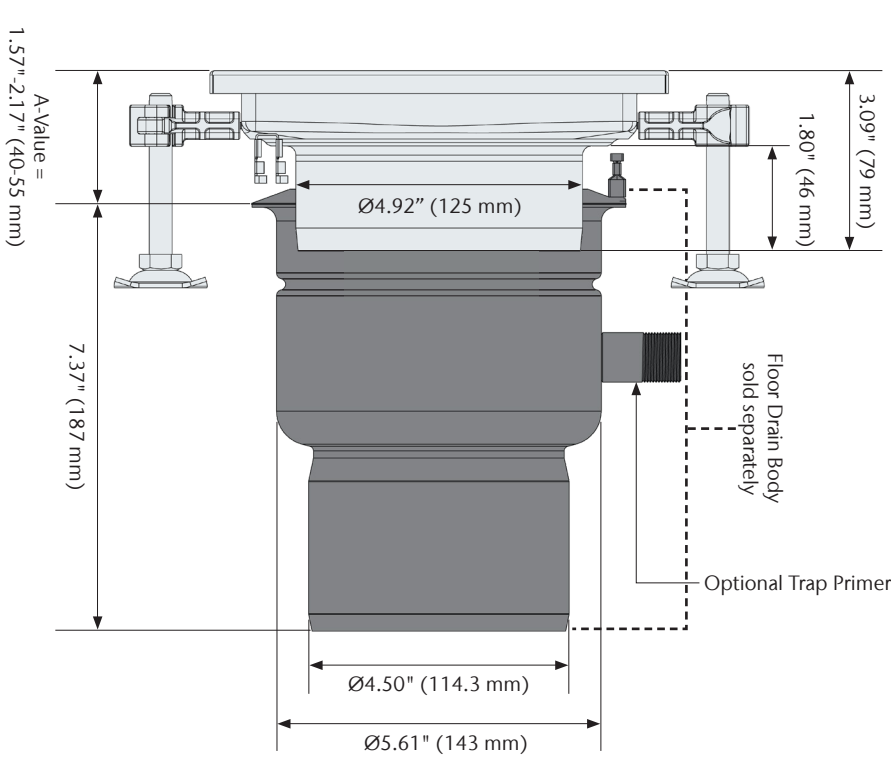

Specification Clause

Used with ACO 8" Hygienic Adjustable Floor Drains. Made from AISI 304 or AISI 316L. Certified to NSF/ANSI/3-A Standard 14159-1.

ACO recommends checking local plumbing codes prior to installation.

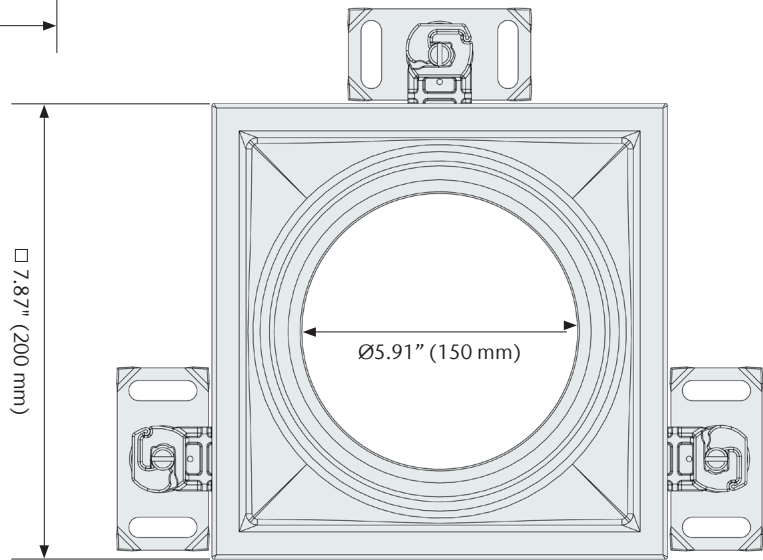

Parts

	Part No.	Material	Weight lbs.
Hygienic Floor Drain, 8" Adjustable Top	414732	AISI 304	2.0
	414832	AISI 316L	2.0

ACO, Inc.

West Sales Office
825 W. Beechcraft Street
Casa Grande, AZ 85122
Tel: (520) 421-9988
Toll-Free: (888) 490-9552
Fax: (520) 421-9899

Northeast Sales Office
9470 Pinecone Drive
Mentor, OH 44060
Tel: (440) 639-7230
Toll-Free: (800) 543-4764
Fax: (440) 639-7235

Southeast Sales Office
4211 Pleasant Road
Fort Mill, SC 29708
Toll-Free: (800) 543-4764
Fax: (803) 802-1063

info@acousa.com
www.acousa.com

© April 2021 ACO, Inc.
All reasonable care has been taken in compiling the information in this document. All recommendations and suggestions on the use of ACO products are made without guarantee since the conditions of use are beyond the control of the company. It is the customer's responsibility to ensure that each product is fit for its intended purpose and that the actual conditions of use are suitable. ACO, Inc. reserves the right to change products and specifications without notice.

ACO. creating
the future of drainage



ACO Specification Information