

Hygienic Floor Drain, 12" Adjustable - Mech. Clamping Flange, 6" Vertical Outlet

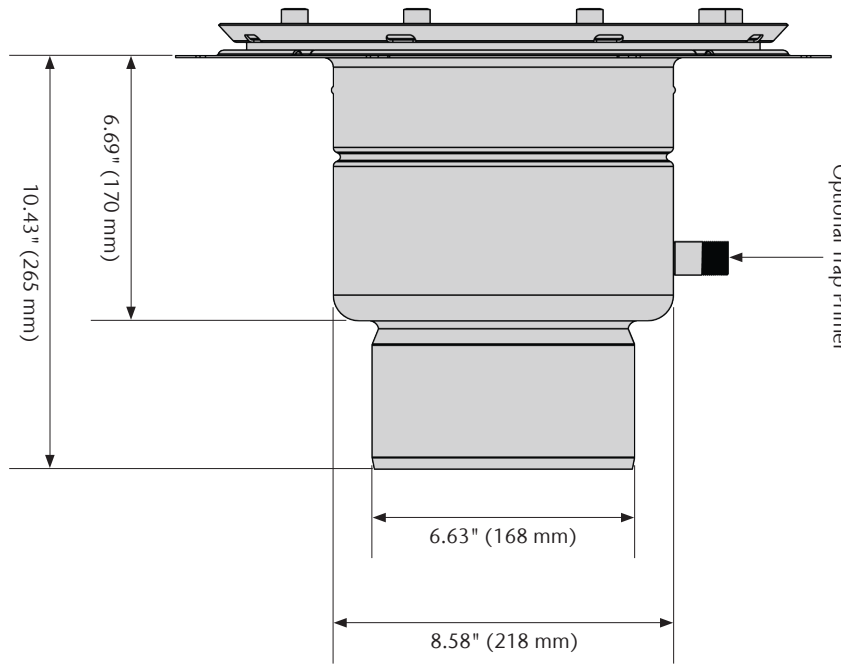
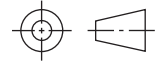

Specification Clause

ACO 12" Hygienic Floor Drain with 6" vertical outlet. Made from AISI 304 or AISI 316L. Uses ACO 12" Hygienic Floor Top. Flow Rates calculated from maximum and minimum height positions. Certified to NSF/ANSI/3-A Standard 14159-1.

ACO recommends checking local plumbing codes prior to installation.

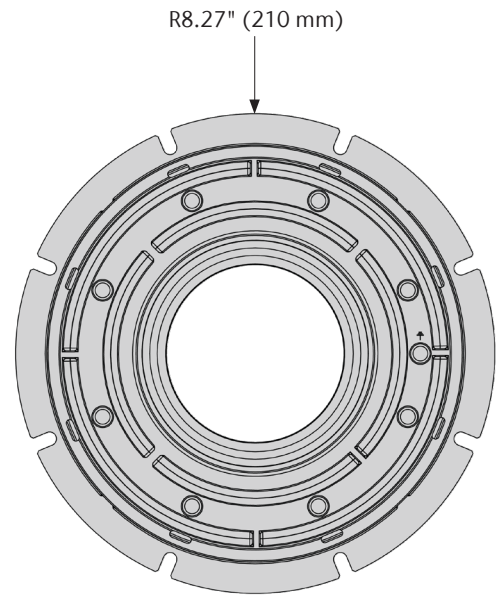

Parts	Part No.	Material	Weight lbs.	Flow Rate GPM*
Hygienic Floor Drain, 12" Adjustable - Mech.	445145	AISI 304	12.5	387 / 403
Clamping Flange with 6" Vertical Outlet	445211	AISI 316L	12.5	387 / 403

ACO, Inc.

West Sales Office
825 W. Beechcraft Street
Casa Grande, AZ 85122
Tel: (520) 421-9988
Toll-Free: (888) 490-9552
Fax: (520) 421-9899

Northeast Sales Office
9470 Pinecone Drive
Mentor, OH 44060
Tel: (440) 639-7230
Toll-Free: (800) 543-4764
Fax: (440) 639-7235

Southeast Sales Office
4211 Pleasant Road
Fort Mill, SC 29708
Toll-Free: (800) 543-4764
Fax: (803) 802-1063

info@acousa.com
www.acousa.com

© May 2021 ACO, Inc.
All reasonable care has been taken in compiling the information in this document. All recommendations and suggestions on the use of ACO products are made without guarantee since the conditions of use are beyond the control of the company. It is the customer's responsibility to ensure that each product is fit for its intended purpose and that the actual conditions of use are suitable. ACO, Inc. reserves the right to change products and specifications without notice.

ACO. creating the future of drainage



ACO Specification Information