

Pipe - Bend 30° - D75 (2.95")

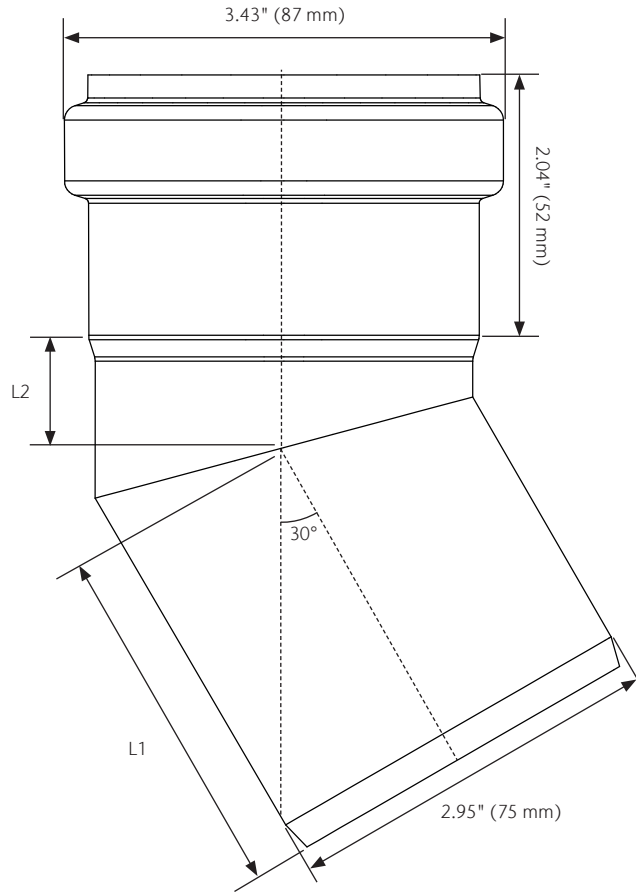
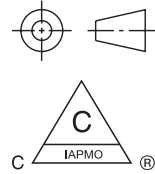

Part No.	Length (L1) in (mm)	Length (L2) in (mm)	Pipe Material	Gasket Material	Weight lbs
98718	2.80 (71)	0.83 (21)	AISI 304	EPDM	0.7
98768	2.80 (71)	0.83 (21)	AISI 316L	EPDM	0.7
98769	2.80 (71)	0.83 (21)	AISI 316L	FPM	0.7

Specification Clause

Used with ACO Pipe D75 OR D75 outlet spigots. Made from 19 gauge (1 mm) AISI 304 or AISI 316L. Resistant to thermal and dynamic shocks. Rodent-proof and sag-proof. Non-combustible. Double-lipped seal push-fit connection. Designed for gravity piping system with maximum working pressure of 0.5 bar. Socket clamps and NBR gasket material also available upon request. Socket clamp can increase maximum operating pressure to 2.5 bar. ACO recommends checking local plumbing codes prior to installation.

ACO, Inc.

West Sales Office
825 W. Beechcraft Street
Casa Grande, AZ 85122
Tel: (520) 421-9988
Toll-Free: (888) 490-9552
Fax: (520) 421-9899

Northeast Sales Office
9470 Pinecone Drive
Mentor, OH 44060
Tel: (440) 639-7230
Toll-Free: (800) 543-4764
Fax: (440) 639-7235

Southeast Sales Office
4211 Pleasant Road
Fort Mill, SC 29708
Toll-Free: (800) 543-4764
Fax: (803) 802-1063

info@acousa.com
www.acousa.com

© October 2020 ACO, Inc.

All reasonable care has been taken in compiling the information in this document. All recommendations and suggestions on the use of ACO products are made without guarantee since the conditions of use are beyond the control of the company. It is the customer's responsibility to ensure that each product is fit for its intended purpose and that the actual conditions of use are suitable. ACO, Inc. reserves the right to change products and specifications without notice.

ACO. creating
the future of drainage



ACO Specification Information